

Timberline® Application Instructions - English

Information Sheet

Updated: 2007



*Quality You Can Trust Since 1886...
From North America's Largest Roofing Manufacturer™*



TIMBERLINE PRESTIQUE[®] LIFETIME
HIGH DEFINITION SHINGLES

TIMBERLINE PRESTIQUE[®] 30
HIGH DEFINITION SHINGLES

TIMBERLINE PRESTIQUE[®] 40
HIGH DEFINITION SHINGLES

TIMBERLINE Natural Shadow[®]
SHINGLES

APPLICATION INSTRUCTIONS

English

Note: These shingles MUST be nailed a nominal 5/8" (143mm) from bottom of shingles, not in or above self seal, as shown. Nails should remain unexposed.

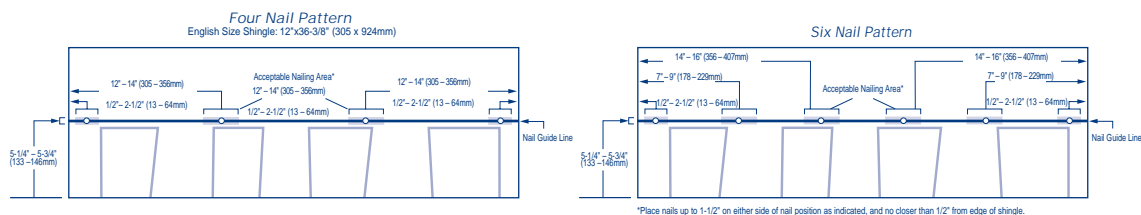

GENERAL INSTRUCTIONS

- **ROOF DECKS:** Wood decks must be well-seasoned, supported, and tightly-constructed with maximum 6" (152mm) wide lumber, having adequate nail-holding capacity and a smooth surface. Plywood or OSB decking as recommended by APA-The Engineered Wood Assn. is acceptable. Do not fasten shingles directly to insulation or insulated deck unless authorized in writing by GAF-Elk. Roof decks and existing surfacing material must be dry prior to application of shingles.
- **UNDERLAYMENT:** Underlayment beneath shingles has many benefits, including preventing wind-driven rain from reaching the interior of the building and preventing sap in some wood decking from reacting with asphalt shingles. Underlayment is also required by many code bodies and is required to maintain the UL Class A fire rating. Where an underlayment is to be installed, use a breather-type underlayment such as GAF-Elk Shingle-Mate[®], Leatherback[®] or Deck-Armor[™] underlayment.
- **FASTENERS:** Use only zinc-coated steel or aluminum, 10-12 gauge, barbed, deformed or smooth shank roofing nails with heads 3/8" (10mm) to 7/16" (12mm) in diameter. Fasteners should be long enough to penetrate at least 3/4" (19mm) into wood decks or just through the plywood decks. Fasteners must be driven flush with the surface of the shingle. Overdriving will damage the shingle. Raised fasteners will interfere with the sealing of the shingles and can back out.
- **WIND RESISTANCE/HAND SEALING:** These shingles have a special thermal sealant that firmly bonds the shingles together after application when exposed to sun and warm temperatures. Shingles installed in Fall or Winter may not seal until the following Spring. If shingles are damaged by winds before sealing or are not exposed to adequate surface temperatures, or if the self-sealant gets dirty, the shingles may never seal. Failure to seal under these circumstances results from the nature of self-sealing shingles and is not a manufacturing defect. To insure immediate sealing, apply 4 quarter-sized dabs of shingle tab adhesive on the back of the shingle 1" (25mm) and 13" (330mm) in from each side and 1"

(25mm) up from bottom of the shingle. Press shingle firmly into the adhesive. For maximum wind resistance along rakes, install GAF-Elk Starter Strip Shingles with GAF-Elk Dura-Grip[®] sealant or cement shingles to underlayment and each other in a 4" (102mm) width of asphalt plastic cement. Caution: Apply ONLY a thin uniform layer of asphalt plastic cement less than 1/8" (3mm) thick. Excess amounts can cause blistering of the shingles and may soften the asphalt in certain underlayments, including StormGuard[®], Weather Watch[®] and other GAF-Elk Leak Barriers, resulting in the asphalt flowing, dripping and staining.

- **RELEASE FILM:** The film strips on the back of each shingle are to prevent sticking together of the shingles while in the bundle. Their removal is NOT required during application.
- **MANSARD AND STEEP SLOPE APPLICATIONS:** For roof slopes greater than 21" per foot (1750mm/m), shingle must be hand sealed (DO NOT use on vertical side walls). See "Wind Resistance/Hand Sealing" for the application of adhesive.
- **SHINGLE TAB ADHESIVE:** Use asphalt plastic cement conforming to ASTM D4586 Type I or II.
- **THROUGH VENTILATION:** All roof structures must be provided with through ventilation to prevent entrapment of moisture-laden air behind roof sheathing. Proper ventilation is also necessary to prevent mold growth. Ventilation provisions must at least meet or exceed current F.H.A., H.U.D. or local code minimum requirements. Note: Minimum net free ventilation area of 1 sq. foot per 150 sq. feet (1 sq. meter per 150 sq. meters) of ceiling area is required. When vents are located at the eaves and near the roof's peak (balanced) for maximum air flow, ventilation may be reduced to 1 sq. foot per 300 sq. feet (1 sq. meter per 300 sq. meters).
- **NON-CORRODING METAL DRIP EDGES:** Recommended along rake and eave edges on all decks, especially plywood decks.
- **EXPOSED METAL:** All exposed metal surfaces (flashing, vents, etc.) should be painted with matching GAF-Elk roof accessory paint.

1 Underlayment: Standard Slope—4/12 (333mm/m) or more

Application of underlayment: Cover deck with one layer of underlayment installed without wrinkles. Use only enough nails to hold underlayment in place until covered by shingles. **Application of eave flashing:** Install eave flashing such as GAF-Elk Weather Watch®, StormGuard®, or other GAF-Elk Leak Barrier in localities where leaks may be caused by water backing up behind ice or debris dams. Eave flashing must not overhang the eave edge by more than 1/4" (6mm) and extend 24" (610mm) beyond the inside wall line.

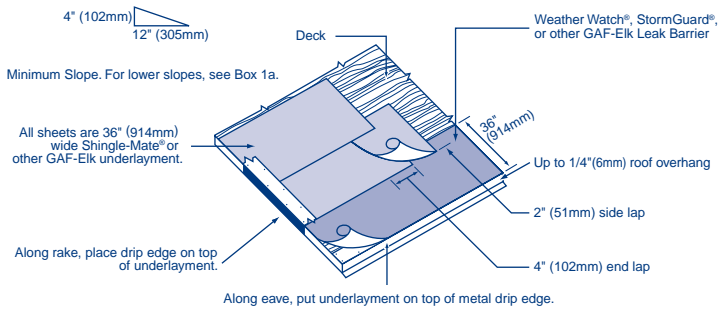

1a Underlayment: Low Slope 2/12-4/12 (167mm-333mm/m)

Application of underlayment and eave flashing: Completely cover the deck with two layers of underlayment as shown. Use only enough nails to hold underlayment in place until covered by shingles. Use blind nailing for eave flashings. At eaves and where ice dams can be expected, use one layer of GAF Weather Watch®, StormGuard® or other GAF-Elk Leak Barrier. Eave flashing must not overhang the roof eave edge by more than 1/4" (6mm) and extend 24" (610mm) beyond the inside wall line. Where ice dams or debris dams are not expected, install 2 plies of Shingle-Mate® underlayment.

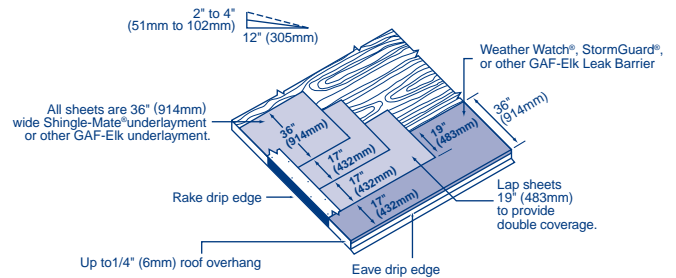

2 Starter Course

Apply as shown. **Note:** GAF-Elk starter strips with sealant are recommended at the eaves and rakes for best performance and required for the best limited wind warranties on certain products (see limited warranty for details).

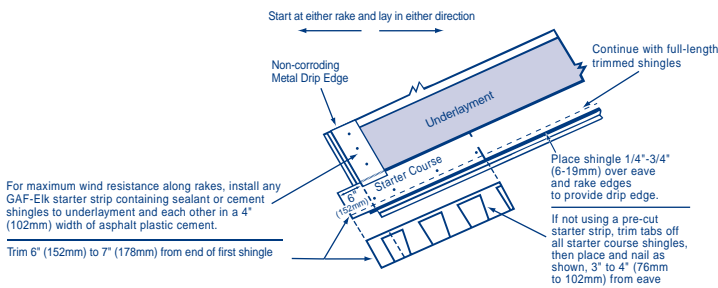

3 First Course

Start and continue with full shingles laid flush with the starter course. Shingles may be laid from left to right or right to left. **DO NOT** lay shingles straight up the roof (racking) since this procedure can cause an incorrect color blend on the roof and may damage the shingles.

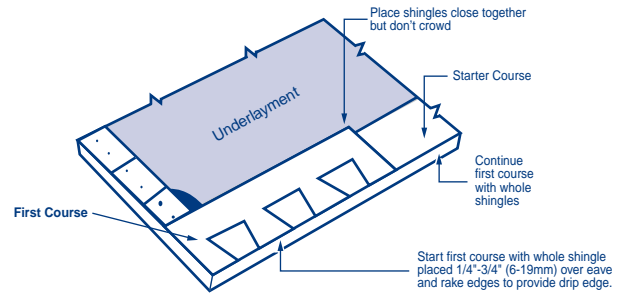

4 Second Course

Start and continue second course as shown. Trim 6" (152mm) from the end of the shingle. Position the shingles in the second and subsequent courses flush with the tops of the wide cut-outs. This results in a 5" (127mm) exposure. Continue with full width shingles across the roof.

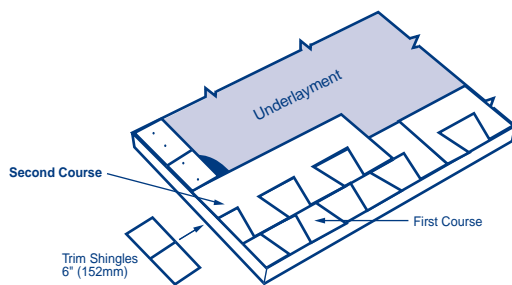

5 Third Course

Trim 11" (279mm) from the first shingle in the course; then continue with full shingles across the roof. Strike a chalk line about every 6 courses to check parallel alignment with eaves. **NOTE:** Shingles may be laid from either left or right-hand side.

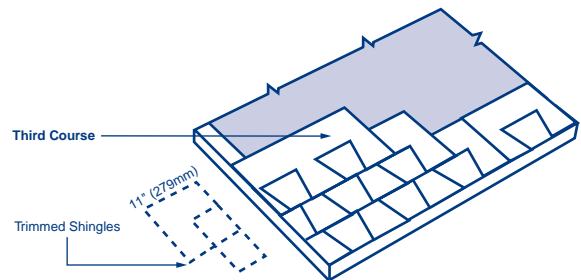

6 Fourth Course and Remaining Courses

Trim 17" (432mm) from first shingle in the course, then continue with full shingles across the roof. Fifth and subsequent courses; repeat Steps 3 through 6.

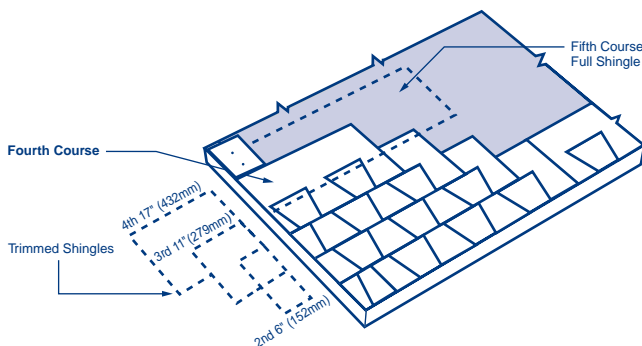

7 Hip and Ridge

Install GAF-Elk Timbertex®, Z®Ridge, Seal-A-Ridge®, or Ridglass® hip and ridge shingles (check regional availability). Follow the application instructions shown on the hip and ridge wrapper.

8 Wall Flashing

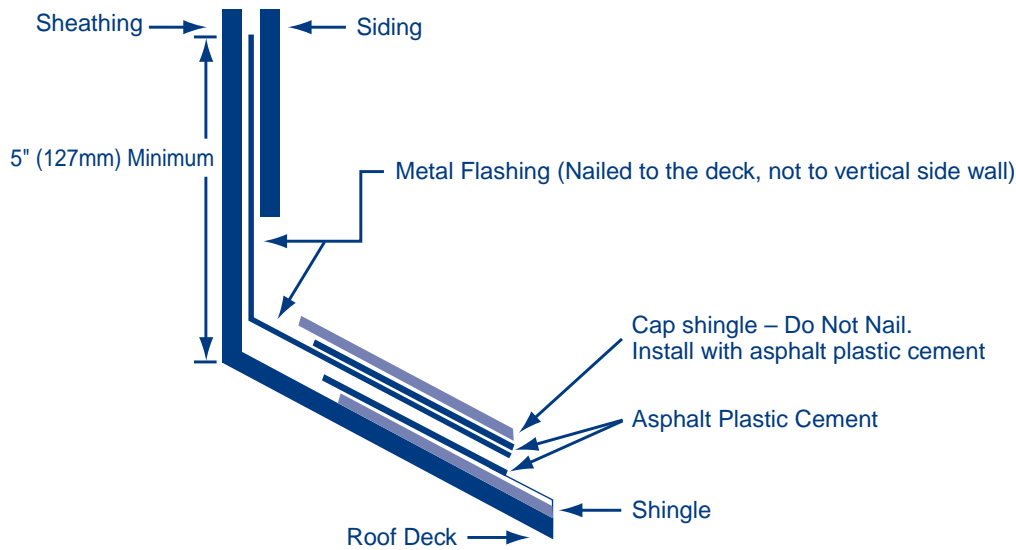

9 Chimney Flashing

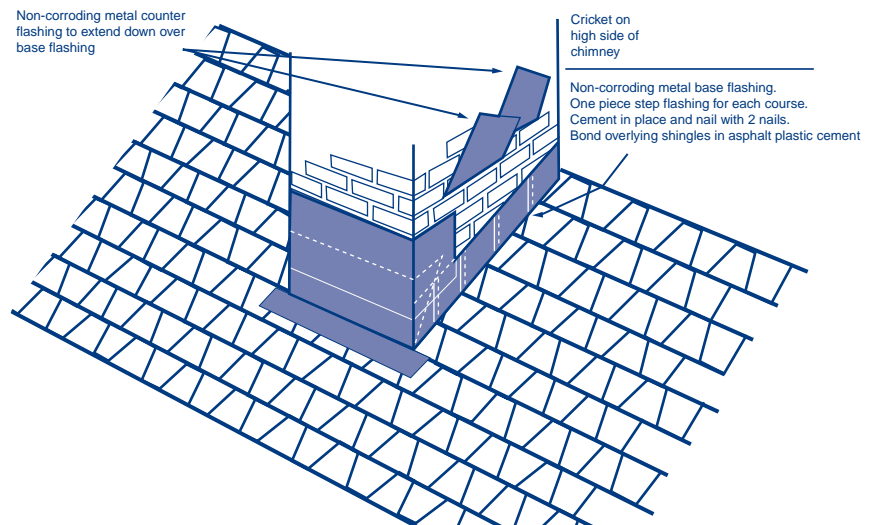

10 Valley Construction - Closed or Woven Valley

Center a full 36" (914mm) width of Weather Watch®, StormGuard® or other GAF-Elk Leak Barrier over entire valley length to seal the valley. Lay Shingle-Mate® or other GAF-Elk underlayment into the valley and overlapping the Leak Barrier a minimum of 6" (152mm). Design the valley for water flow over the trimmed shingle by installing the valley beginning with the roof plane that has the lower slope or lesser height. Extend the bottom shingles 12" (305mm) past the valley center line. Use normal shingle fastening methods (no fasteners within 6" (152mm) of valley center line, two nails at the shingle's end). Continue to the top of the valley in the same manner. Trim shingles 2" (51mm) back from valley center line on top roof plane. Clip shingle corners after the cut to keep water flow in the valley center. Seal the valley using plastic roof cement; seal the valley shingles to each other for the best protection. (Note: Excess cement can cause shingle blisters).

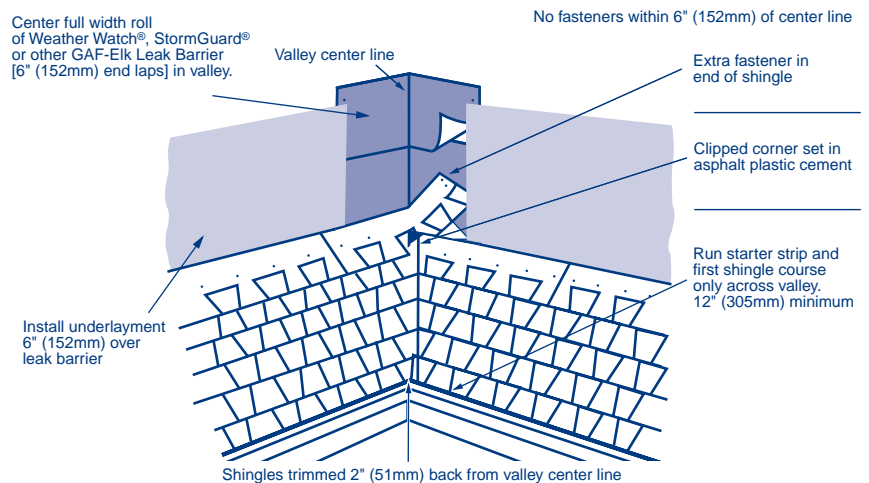

11 Valley Construction—Open Cut

Center a full 36" width of Weather Watch®, StormGuard® or other GAF-Elk Leak Barrier over entire valley length to seal the valley. Lay Shingle-Mate® or other GAF-Elk underlayment into the valley and overlapping the leak barrier a minimum of 6". Center valley metal using 20" (508mm) wide aluminum, galvanized steel, copper, or other non-corroding, non-staining metals (24 gauge minimum). Embed the metal laps in asphalt plastic cement a minimum of 12" (305mm).* Nail the metal on the edges so the nail heads hold it in place. Do not puncture the metal. Nailing through the metal may cause leaking and buckling due to movement. Install shingles to the valley, covering the metal 4" (102mm) minimum on each side to seal. Clip the top corners to keep water flow toward the valley center. Taper the valley shingles to handle increasing water volume. Start at 6" (152mm) wide at the valley top, widen 1/8" (3mm/m) per foot toward the eave (snap chalk lines to ensure shingles diverge properly in valley). Embed the shingle ends in plastic cement to seal the shingles to the metal and keep water from running under them.*

*Note: Excess cement can cause shingle blisters.

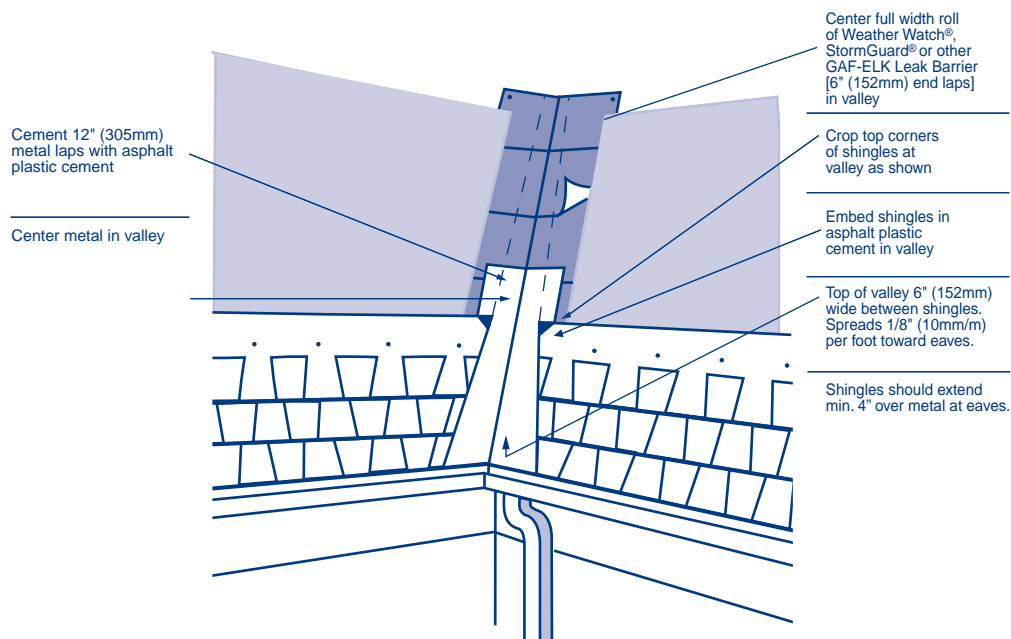

Precautionary Notes

These shingles are fiberglass, self-sealing asphalt shingles. Because of the natural characteristics of the high quality waterproofing material used, these shingles will be stiff in cold weather and flexible in hot weather.

1. These shingles are particularly tough, heavyweight shingles with a definitely rugged-looking appearance. They require additional effort to trim to fit on the roof. Curved blade utility knives are more effective than straight blade utility knives in cutting these shingles. Using a circular saw equipped with carbide-tipped blades is also effective.
2. Regardless of the tool used, always wear proper protective wear, i.e. gloves, eye protection, etc; follow all protection procedures and use tools carefully to prevent personal injury when working with these heavier products.
3. Do not drop bundles on edge or on other bundles to separate shingles. Do not load bundles across a hip or ridge. Do not bend bundles over shoulder for carrying. Premium weight may cause cracks at sharp bend points.
4. Handle carefully. Shingles can easily be broken in cold weather or their edges damaged in hot weather.
5. Store on flat surface, in a covered, ventilated area—maximum temperature 110°F (43°C). Do not store near steam pipes, radiators, etc., or in sunlight.
6. GAF-Elk does not recommend long-term storage of double stacked pallets. If double stacking is required for short periods, slip sheets of 1/2" (13mm) plywood cut to the pallet size are required between pallets to minimize damage. Long-term double stacked storage, especially in hot weather, can result in possible sticking, staining and distortion of the shingles in the lower layers of shingle bundles.
7. If shingles are to be applied during PROLONGED COLD periods or in areas where airborne dust or sand can be expected before sealing occurs, the shingles MUST be hand sealed. See "Wind Resistance/Hand Sealing" instructions.

IMPORTANT: Repair leaks promptly to avoid adverse effects, including mold growth.

Re-Roofing

If old asphalt shingles are to remain in place, nail down or cut away all loose, curled or lifted shingles; replace with new; and just before applying the new roofing, sweep the surface clean of all loose debris. Since any irregularities may show through the new shingles, be sure the underlying shingles provide a smooth surface. Fasteners must be long enough to penetrate the wood deck at least 3/4" (19mm) or just through plywood. Follow above instructions for application.

Note: Shingles can be applied over wood shingles if the surface can be made smooth enough. This may include cutting back old shingles at eaves and rakes, installing new wood edging strips as needed, and the use of beveled wood strips. Install #30 underlayment to maintain Class A rating.

For more information, visit our website at www.gaf.com or call Technical Services at 1-800-ROOF-411.

This product is sold with an express LIMITED WARRANTY only. A copy of the LIMITED WARRANTY stating its terms and restrictions is printed on the product wrapper or may be obtained from the distributor of this product or directly from GAF-Elk Corporation. Any deviation from printed instructions shall be the responsibility of applicator and/or specifier.